

The CubeSat „BEESAT-1“ during the system integration

SATELLITE TECHNOLOGY

Klaus Briess | Chair of Space Engineering| Berlin Summer School 2014

Table of Contents

1. Definition of the terms satellite and satellite bus and classifications of satellites
2. Elements of a satellite mission
3. Segments of a satellite mission and mission architecture
4. Examples of innovative CubeSat payloads

DEFINITION OF THE TERMS SATELLITE AND SATELLITE BUS AND CLASSIFICATIONS OF SATELLITES

Definition: Satellite

- satellitis, satelles (Lat.) = companion on the way, protector
- middle ages to approx. 1500: armed companion
- 1611: Jupiter's 4 moons discovered by Galileo with his telescope were described as "satellites" for the first time by Kepler
- 1957: use of the concept "artificial satellite" for the first time
- modern meaning:
- **satellite** = little body which moves around a large body
 - **a natural satellite** = moon of a planet
 - **an artificial satellite** = (unmanned) spacecraft which moves around the Earth
- interplanetary spacecraft is called a **space probe** or more general spacecraft



Sputnik-1

Satellite = Bus and Payload

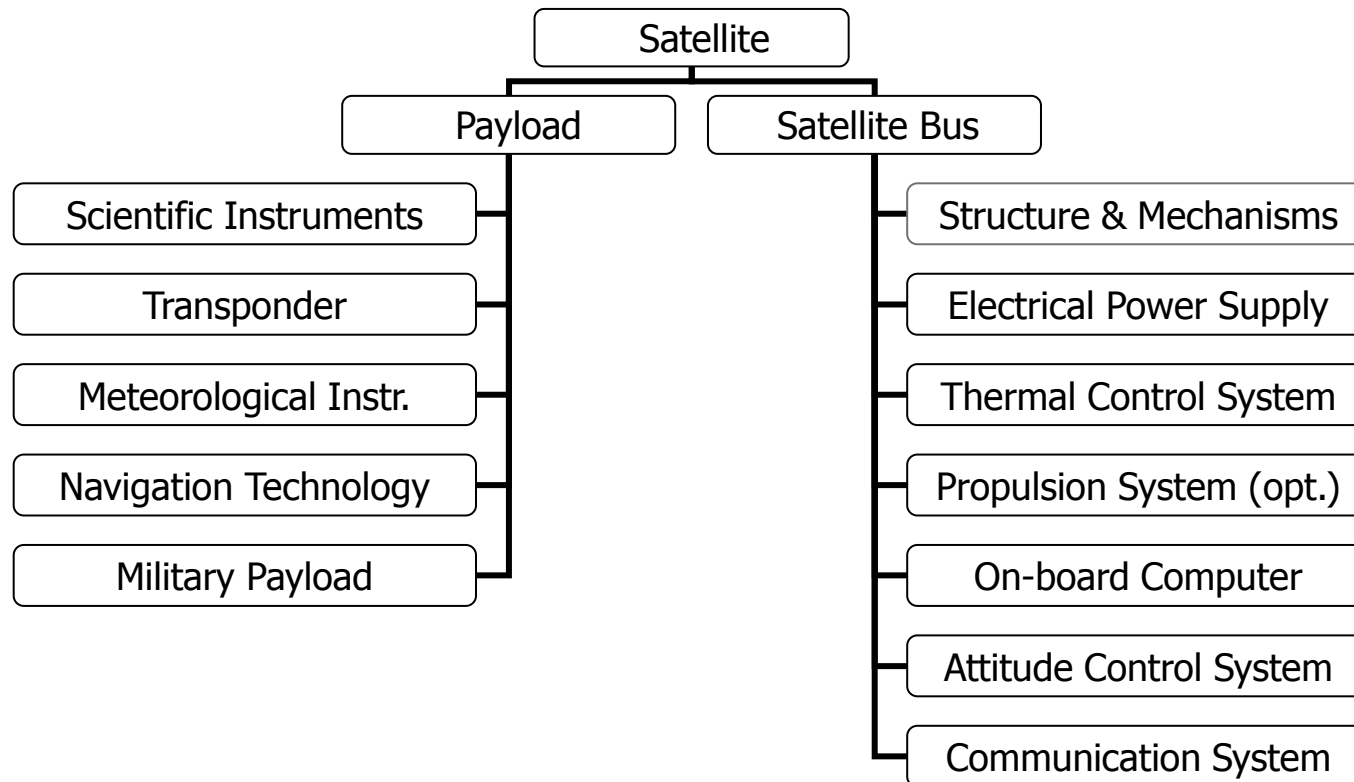

Satellite Bus

= system for payload placement and supply during the desired mission task. The bus must fulfil the following functional requirements:

1. The payload must be carried and held stably and mechanically at very different environmental influences (transportation, launch, space).
2. The payload must be transported and held into the mission space.
3. The payload must be supplied with electrical power.
4. The payload must be kept in one temperature interval.
5. The payload must be pointed to the bore sight direction and held with one defined stability.
6. The payload must be controlled and operated from the ground.
7. The payload data must be transmitted to ground and buffered when required.

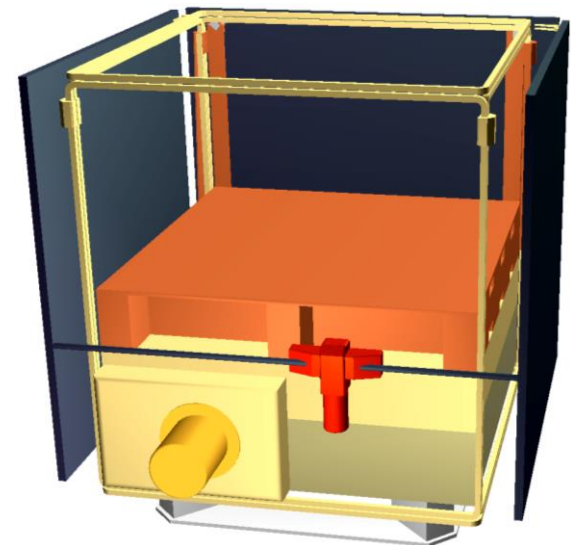

The BIRD satellite bus [image: DLR]

Satellite Classifications

Satellites can be classified according to different criteria.

Typical classifications are according to

- application,
- orbit type,
- type of attitude stabilization,
- total satellite mass.

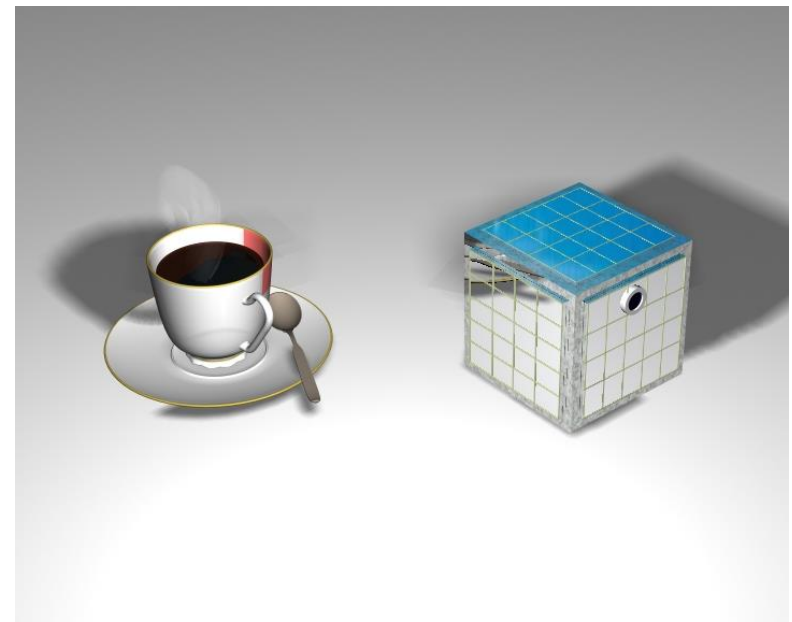

A CubeSat satellite in the comparison to a cup of coffee

Satellite Classification According to Application

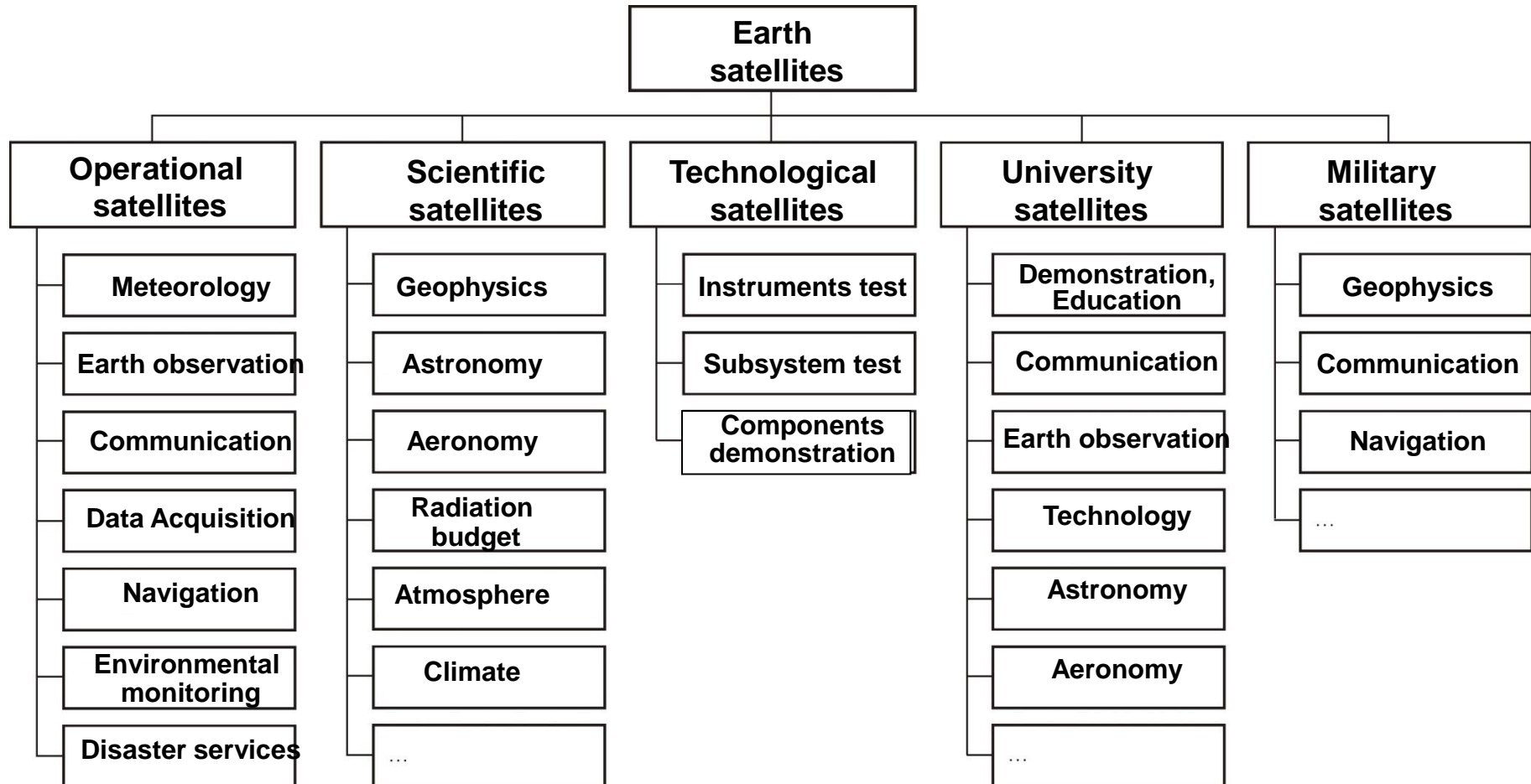

Satellite Classification According to Orbit Type

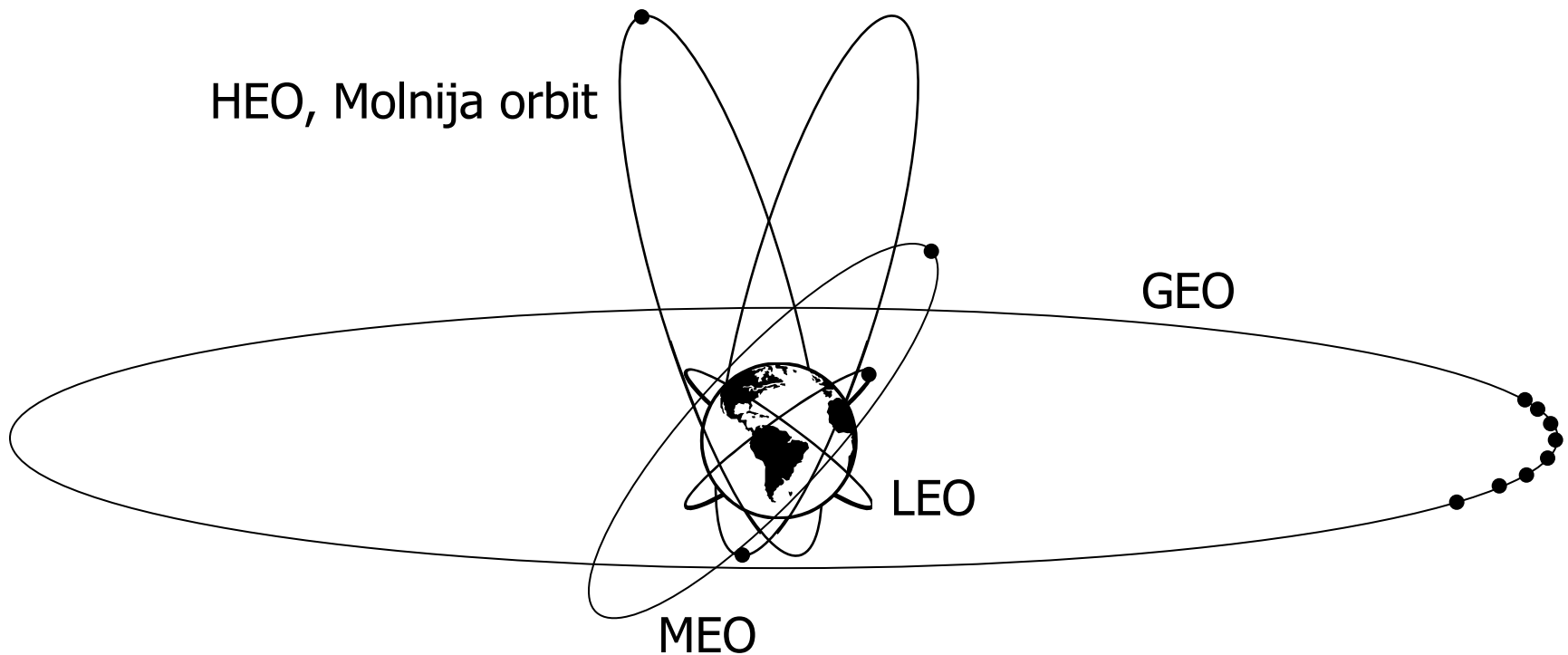

LEO - Low Earth Orbit
HEO - High Elliptical Orbit

MEO - Medium Earth Orbit
GEO - Geostationary Orbit

Satellite Classification According to Orbit Type

Characteristics	LEO Satellites	MEO Satellites	GEO (Geo-stationary) Satellites	HEO-Satellites (Molniya)
Mean orbit altitude [km]	300-1000	6000-25000	35786	500x36000
Inclination [Grad]	0-99	arbitrary	0	63,44
Orbital Period [hr]	approx. 1,5	approx. 5-12	24	12
times of contact time [hr]	approx. 10 min	2-4	24	11
Utilisation	miscellaneous	GNSS, Com.	Com., EO	Com.

LEO - Low Earth Orbit
HEO - High Elliptical Orbit

MEO - Medium Earth Orbit
GEO - Geostationary Orbit

Satellite Classification According to Type of Stabilization

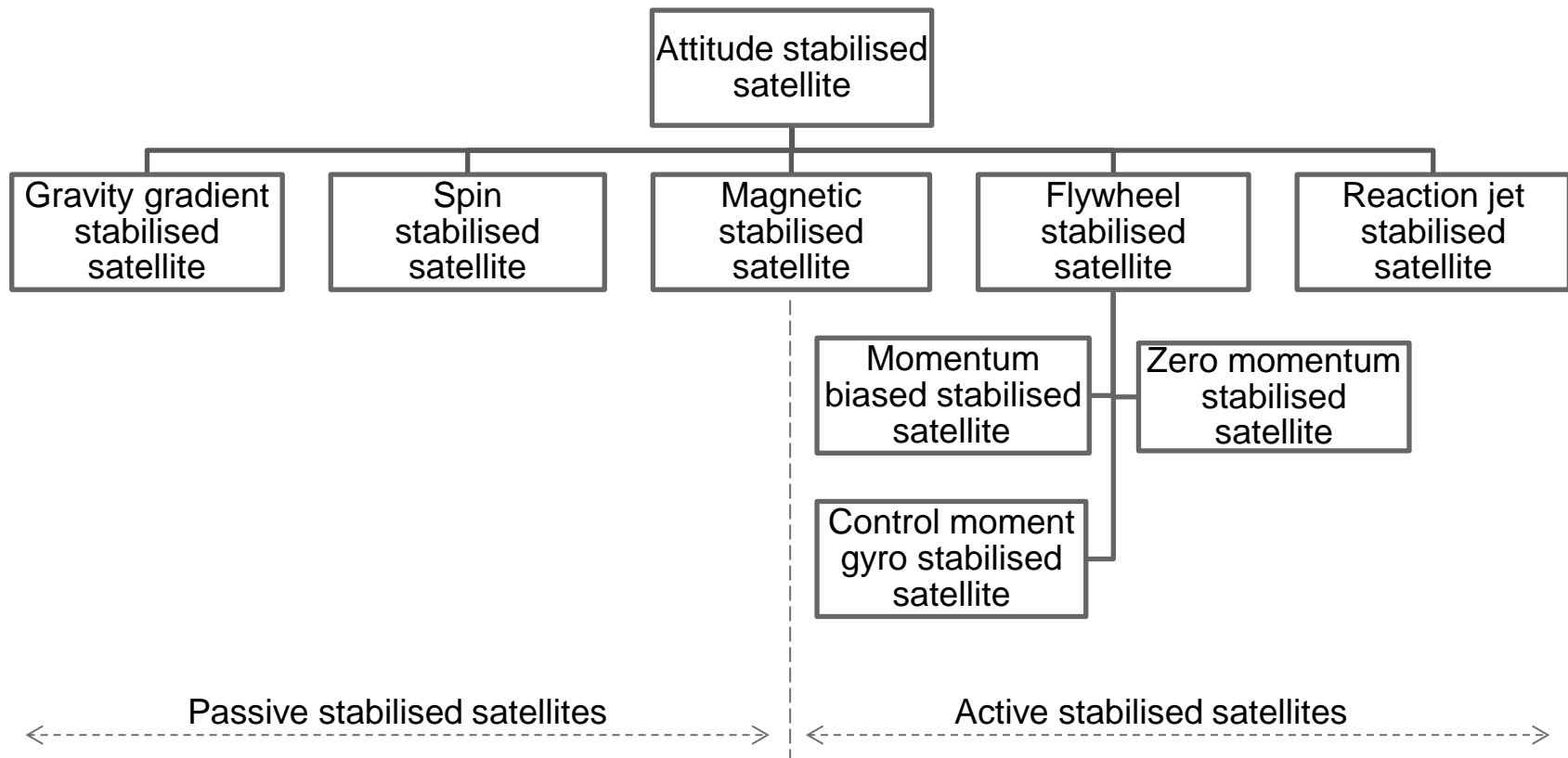

Gravity Gradient Stabilised Satellite



Geosat satellite [image: NASA]

Torque:

$$T_{\text{eg}} = \frac{3GM}{r^3} (\text{MOI}_z - \text{MOI}_y) \sin(2\theta)$$

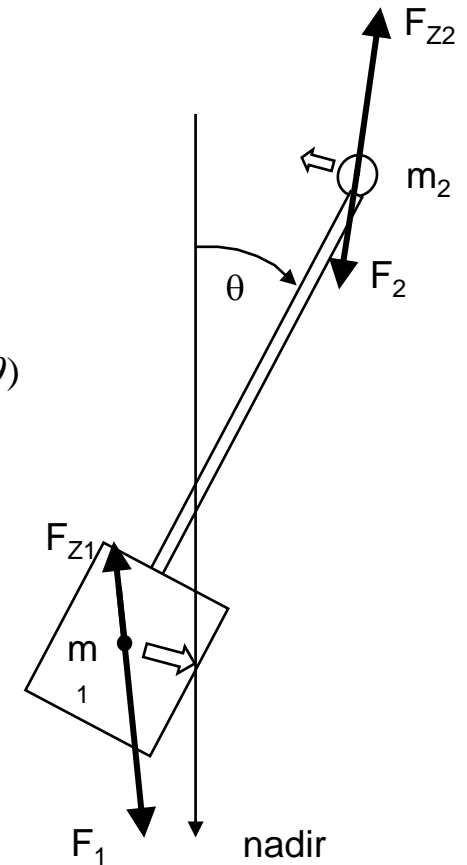

Principle of gravity gradient stabilisation
 GM – Gravitational constant of Earth
 MOI – Moment of Inertia
 r – distance to Earth centre

Spin Stabilised Satellite

- A drum-shaped satellite rotates around the axis with the highest moment of inertia.
- The rotation gives stability on all three axis against distortions.
- Simple and robust type of stabilisation with low need on satellite resources (passive stabilisation).
- The spin stabilisation can also be implemented as an double spin satellite with a payload platform pointing to the Earth continuously.

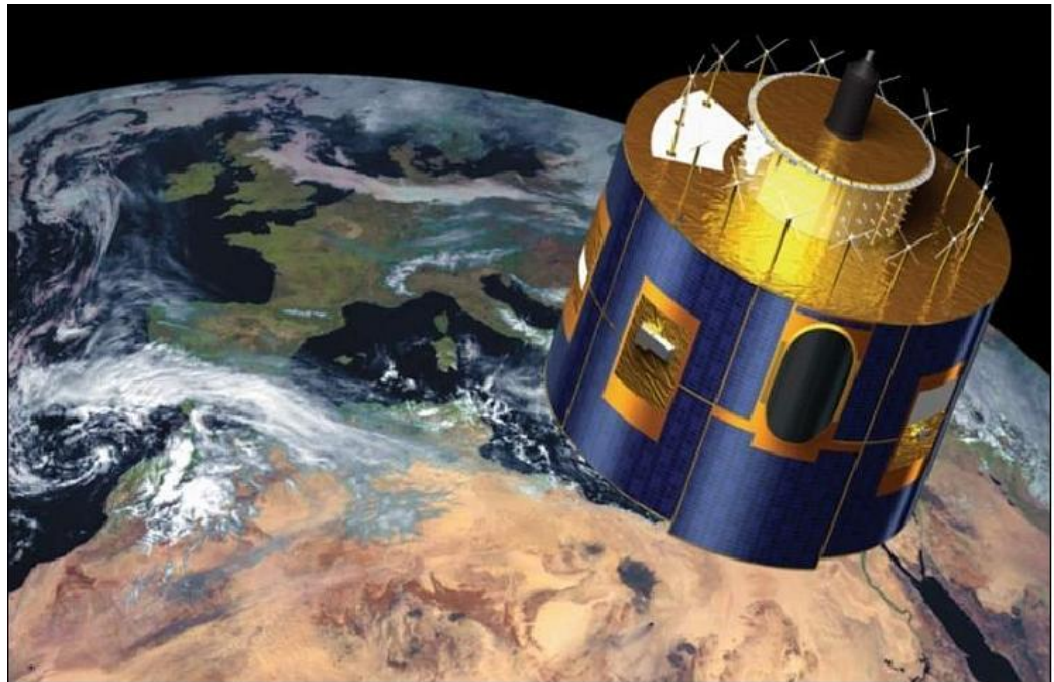

Spin stabilised MeteoSat-8 satellite (image: EUMETSAT)

Magnetic Stabilised Satellite

two methods:

Passive magnetic stabilisation:

Use of the interaction of the remanent magnetism of a satellite or an built-in permanent magnet with the Earth magnetic field

Active magnetic stabilisation:

coils or torquers in the satellite generate active magnetic field for interaction with the Earth magnetic field, 2 axis stabilisation achievable

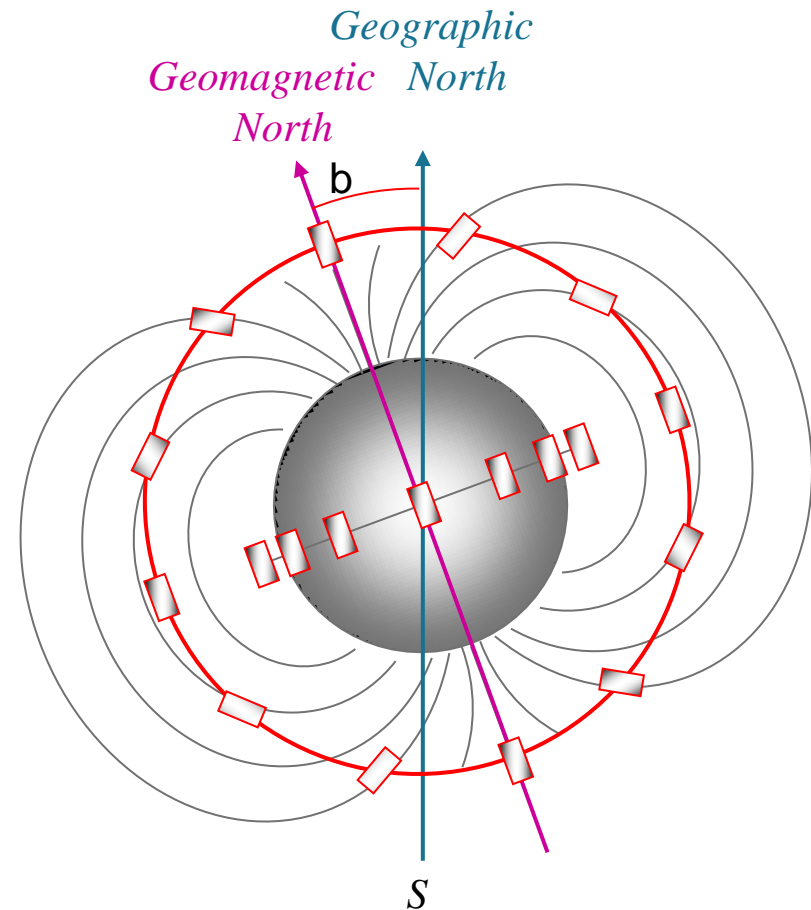

Magnetic stabilised satellite [image: P. Berlin, 2005]

Flywheel Stabilised Satellite

3 types of flywheel stabilised satellite

a) Momentum1-biased stabilised satellite with a momentum wheel

b) zero-momentum stabilized satellite with a set of 3 or 4 reaction wheels,

c) Control moment gyro stabilised satellite with one ore more control moment gyroscopes for a high agility of the satellite

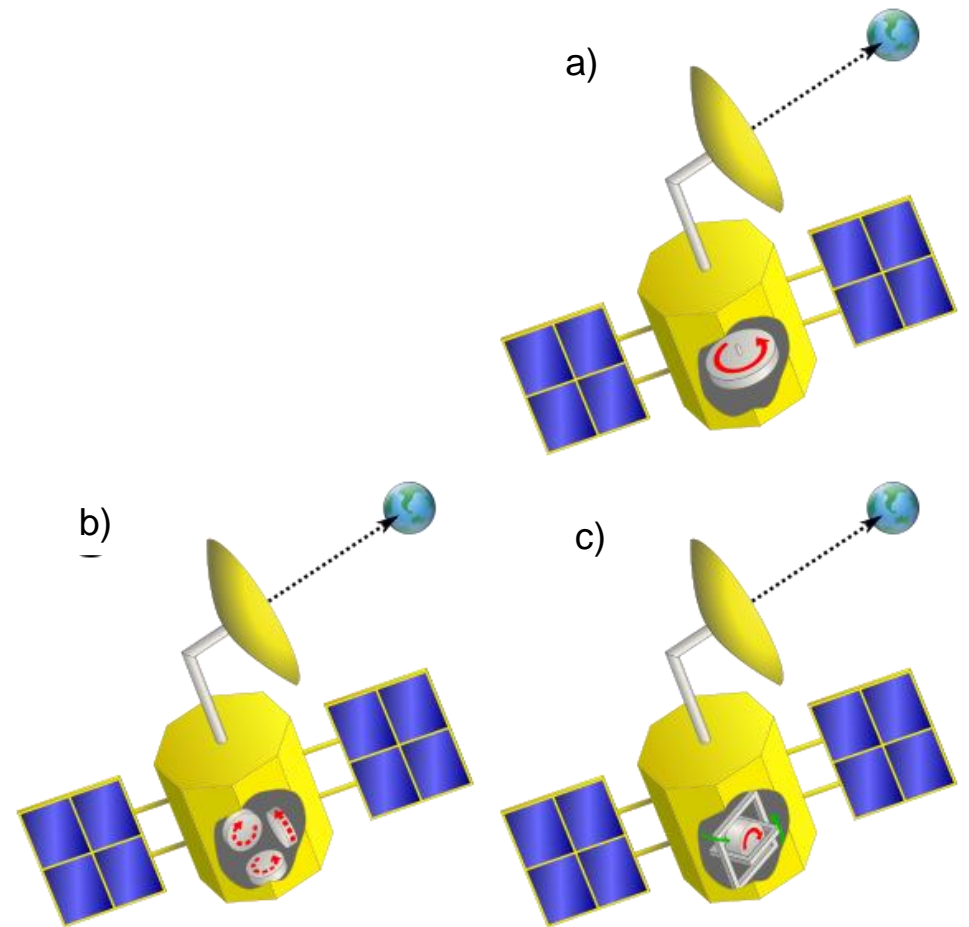

Satellite Classification According to Type of Stabilization

Satellite Class by Type of Stabilization	Accuracy [degree]	Remarks
Gravity-gradient stabilised satellite	1-3	passive, simple, low cost, nadir oriented, inflexible, inaccurate
Magnetic stabilised satellite	1-5	passive or active, simple, low cost, oriented according to the magnetic field lines, inflexible, inaccurate
spin stabilized satellite	0,1	passive, simple, low cost, inertial oriented
Momentum-biased stabilised satellite	0,01	high accuracy, smaller flexibility, moderate position changes, expensive
Zero-momentum stabilised satellite	0,01	high accuracy, high flexibility, relative quick attitude changes, expensive
Control momentum gyro stabilised satellite	0,01	high accuracy, high flexibility, high agile attitude changes, very expensive
Three-axis stabilised satellite by thrusters/jets	0,1	high flexibility, quick attitude changes of also large systems, very expensive, uses propellant

Satellite Classification According to Satellite Mass

Definition of small satellite classes according to the mass definition of IAA [1] and typical ranges of cost and development time

Satellite class	Total mass	Total cost	development time
Mini satellites	≤ 1000 kg	100 Mio US\$	5-6 years
Micro satellites	≤ 100 kg	10 Mio US\$	2-4 years
Nano satellites	≤ 10 kg	1 Mio US\$	2-3 years
Pico satellites	≤ 1 kg	< 1 Mio US\$	1-2 years

Pico satellites of TU Berlin filling the CubeSat standard [2] are able to launch with a launch service provider accepting the CubeSat launch container and a typical CubeSat qualification program.

Reference:

[2] "CubeSat Design Specification Rev. 12". *California State Polytechnic University*. Retrieved 2010-10-16.

Example of a CubeSat: BEESAT-1

Mission Objectives

- In-orbit verification of newly developed reaction wheels
- Education of students in satellite design and operation
- Verification of pico satellite technologies

Funding

German Aerospace Center (DLR)
(Ref. No. 50JR0552)

Launch

23 Sept. 2009, 06.21 UTC with PSLV-C14
Orbit: ≈ 730 km, 98.3° (sun-synchronous)

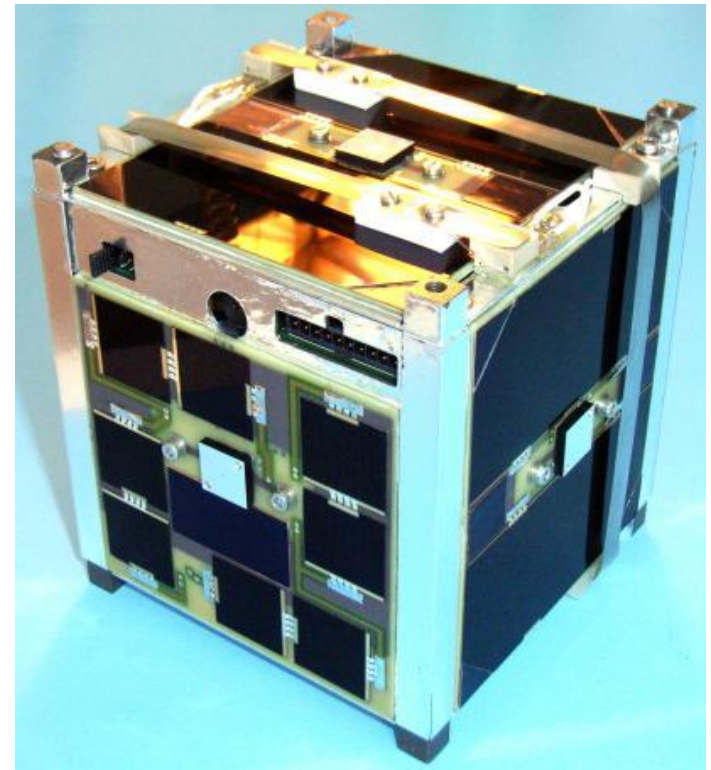

BEESAT flight model

BEESAT - Berlin Experimental and Educational Satellite

ELEMENTS OF A SATELLITE MISSION

Elements of a Satellite Mission

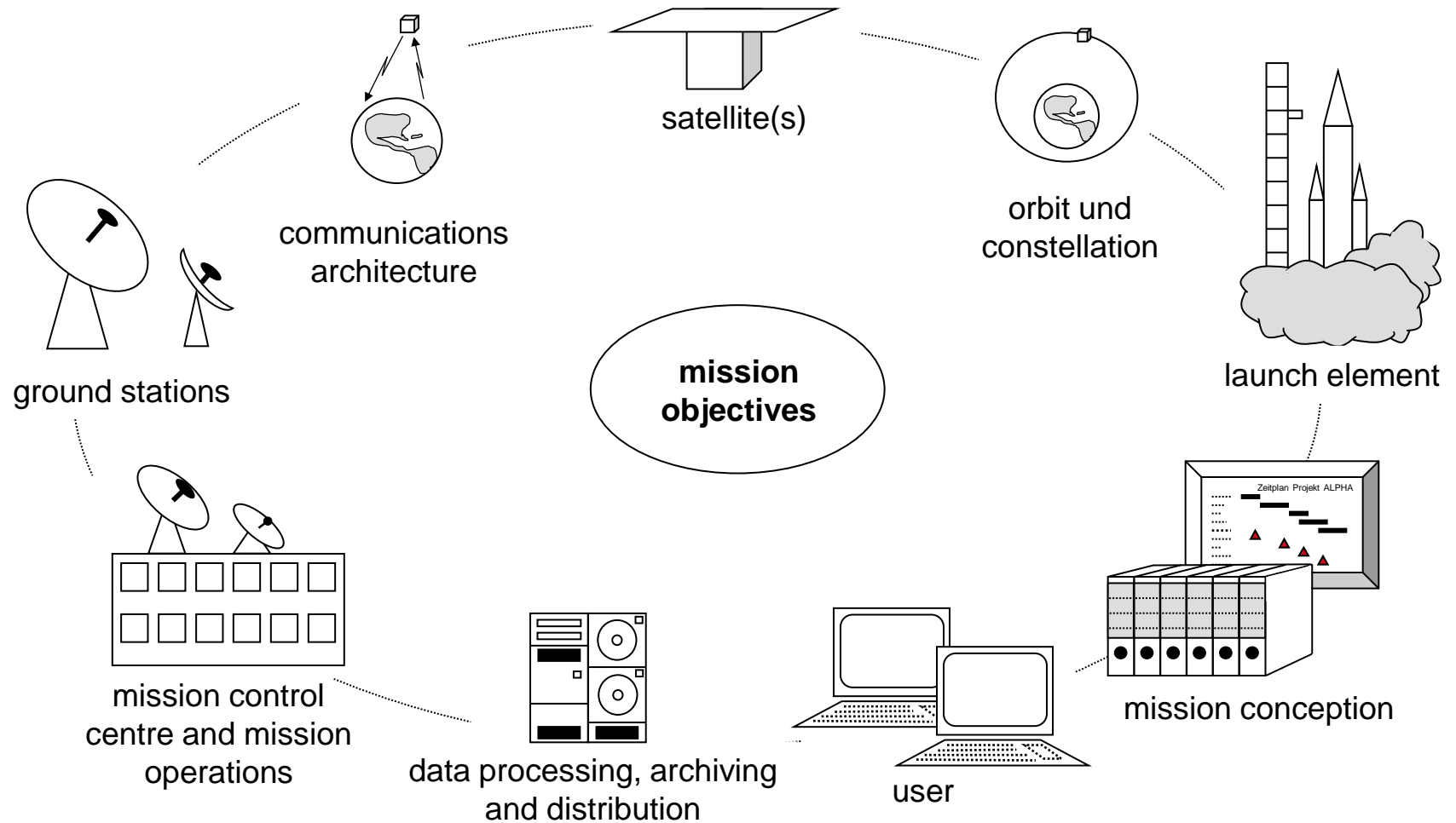

Elements of a Satellite Mission: Mission Objectives

The mission objectives includes

- the reason and the purpose of the space mission,
- the target and the subject of the mission,
- the benefit of the mission.

The mission objective can imply e.g.

- the operational weather monitoring for weather service organisations,
- the investigation of phenomena on the Earth surface,
- space research for scientific establishments,
- communication applications,
- on-orbit verification of new technologies or methods,
- technology demonstration,
- other.

Elements of a Satellite Mission: Mission Conception

The mission conception includes the development, the integration and test, the implementation, the operations and the disposal conception of the space mission.

It comprises the following sub-conceptions:

- conception for accomplishment and utilisation of the mission objectives,
- technical plan for implementation of the mission with all mission elements,
- mission operations conception,
- management plan,
- Model and test philosophy,
- time schedule for the mission implementation,
- cost plan and
- financing conception.

Elements of a Satellite Mission: Launch Element

The launch element is the space transportation system for the transport of the space element into the space. It consists of

- the rocket including the upper stage for the transportation within the space
- the launch pad,
- the launch facility,
- integration buildings,
- the launch control centre,
- technical equipment and facilities for the ground support,
- the launch campaign.

An important part of the launch element is the launch strategy:

- a dedicated single launch,
- a shared launch between two or more (launcher) payloads,
- a launch as auxiliary payload (“piggyback” launch).

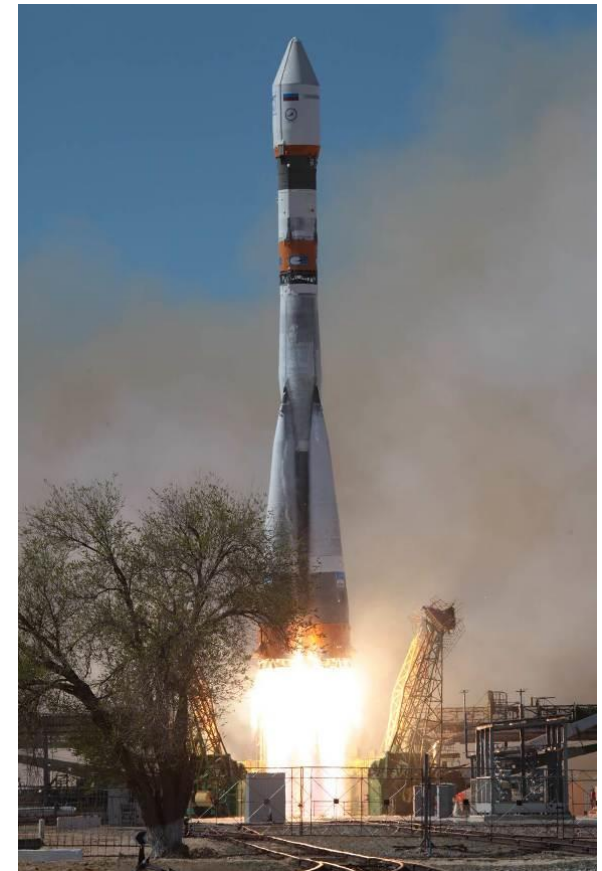

Launch of Sojus 2.1a with Bion-M1 and BEESAT-2 and -3 and other satellites
[image: Roskosmos]

Elements of a Satellite Mission: Orbit and Constellation

The orbit of a satellite mission is a periodic ellipsoid or circular flight path of the satellite around the Earth. Some main types of orbits are already pointed out.

Classifying the orbits by functional criteria:

- **Injection orbit**, orbit of separation between upper stage and payload,
- **Parking orbit**: where the spacecraft parks temporarily before it travels to its destination,
- **Transfer orbit**, flight path of a satellite from the initial orbit to a target orbit,
- **Target orbit** – orbit to fulfil the mission objectives,
- **Graveyard orbit** – orbit for disposal the satellite after the end of the mission.



Spacecraft in a graveyard orbit can still pose a threat [image: ESA]

The Sun, Moon and Earth's oblateness lead to long-periodic perturbations of the inclination of geostationary satellites. The period is 54 years and the maximum inclination is 15° . Thus, uncontrolled satellites will steadily gain an inclination of 15° after 27 years. They will then cross the geostationary orbit twice a day with a velocity of 3,000 kms/hour with respect to other, controlled geostationary satellites.

Elements of a Satellite Mission: Orbit and Constellation

A **satellite constellation** is a geometric arrangement of at least two satellites in given fixed orbits controlled by ground dedicated to the same mission objectives. A constellation increase the spatial and time coverage of the Earth. Satellite constellations are already established for communications, for Earth observation and weather monitoring and for navigation.

A **satellite formation** is a geometric arrangement of at least two satellites in a relatively near distance with a close-loop on-board orbit control. The satellite formation is dedicated to the same mission objectives. It is often called **formation flying** or also **satellite cluster**.

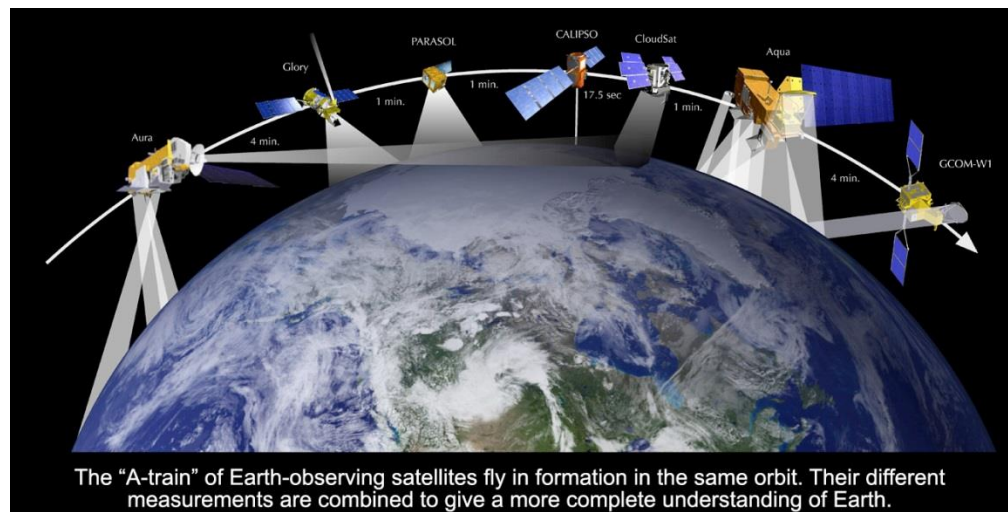

[image: NASA]

Elements of a Satellite Mission: Satellite(s)

A **satellite** is an artificial un-manned celestial body orbiting around the Earth. The satellite(s) is(are) the central element for achieving the mission objectives of a space mission. It consists of the satellite bus and the payload.

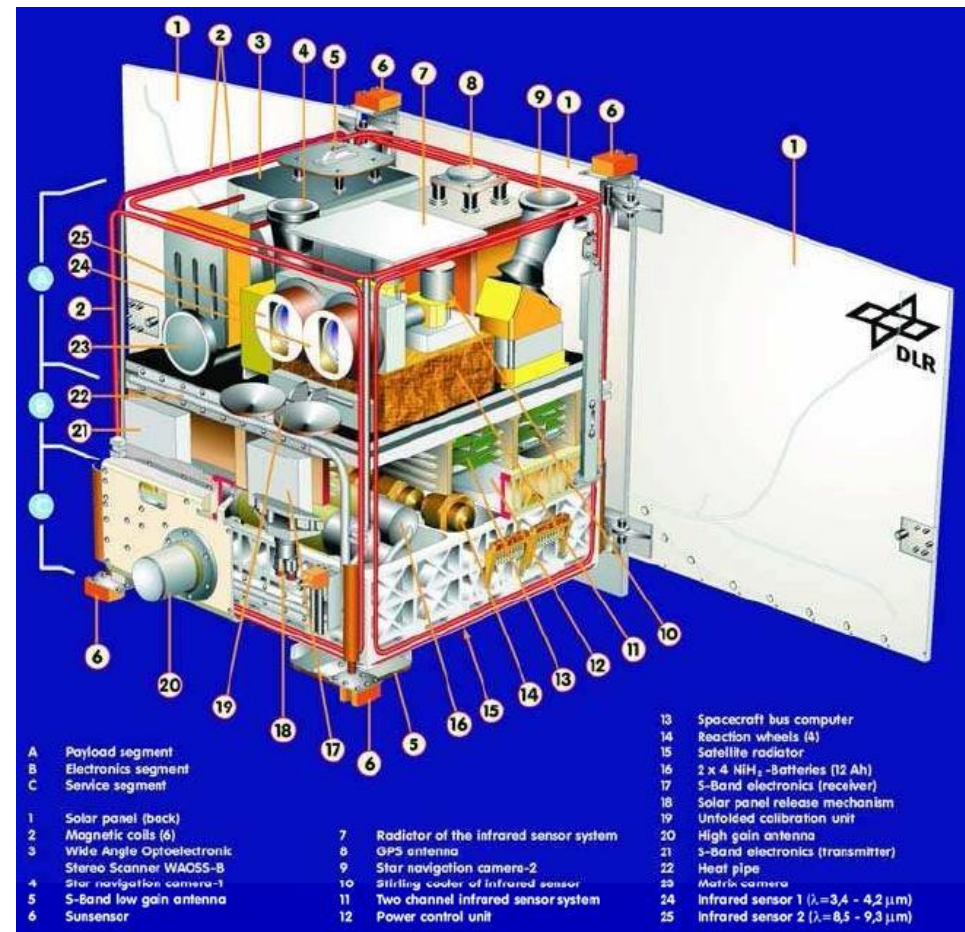

The BIRD spacecraft with payload
[image: DLR]

Elements of a Satellite Mission: Communication Architecture

The communication architecture describes the interrelationship of all communication elements, communication paths and communication systems of a mission.

Two basic architectures:

The **point-to-point architecture** is characterized by a link between the space element and one ground station straight or via relay satellite for the transmission of commands, telemetry data or science data.

The **broadcast architecture** is distinguished by the non-directional transmission of data, telemetry or commands to many receiving stations, straight or via relay satellite. The transmitter can be one single ground station or a single satellite and the receiver are many satellites or many ground stations.



point-to-point architecture

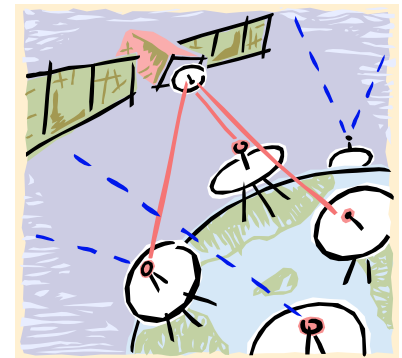

broadcast architecture

Elements of a Satellite Mission: Communication Architecture

With reference to the main architecture classification further it can be distinguished in:

Store-and-forward-communication:

Data or messages from one or several ground stations will be received and buffered by the satellite for a certain time (distance) and then transmitted to the target ground station(s) as point-to-point connection or as broadcast service,

Telemetry and telecommand communication:

The telemetry data of the satellite are transmitted straight or via relay satellite to a single ground station (point-to-point) or to different ground stations (broadcast). The commands are transmitted from a ground station to a single satellite (point-to-point) or to several satellites (broadcast).

Data collection architecture:

Data are collected from ground by satellite sensors or by communication systems and transmitted straight or via relay satellite to a single ground station (point-to-point) or via broadcast to the ground.

Data relay architecture:

A relay satellite transmits data from a ground station or from a satellite to one (point-to-point) or to several ground stations (broadcast).

Elements of a Satellite Mission: Ground Station

A **satellite ground station** comprise the transmitting and receiving systems on ground for communication with the satellite. It consists of:

- A **controllable antenna** for receiving of telemetry and payload data of the satellite and for transmitting of commands,
- An **antenna control system** for orientation, justification and tracing the directed antenna to the satellite. The satellite tracking mode can be accomplished as “programme tracking” by using calculated flight path data or as “auto tracking” by using the received signal power,
- An **Antenna feed** with the radio frequency part of the receiver or transmitter including a Low Noise Amplifier (LNA) for received signals, and often including a down-converter for transmitting the signal to the receiver in an intermediate frequency range,
- A **receiver unit** with de-modulator and with bit-synchroniser and frame-synchroniser for digital signals,
- A **+transmitter unit** with high frequency generator, modulator, up-converter, and high frequency amplifier.



S-Band Antenna of TU
Berlin (Ø 3m)

Elements of a Satellite Mission: Mission Control Centre and Mission Operations

The **Mission Control Centre** is the technical institution for monitoring, controlling and operating of the satellite and of all necessary ground elements and resources.

It can be divided in three functional parts:

The **spacecraft control centre**: It monitors, commands and operates the spacecraft bus.

The **payload control centre**: It monitors, commands and operates the payload of the satellite.

A **ground data system control** for monitoring and control of the appropriate ground elements and resources including connections.

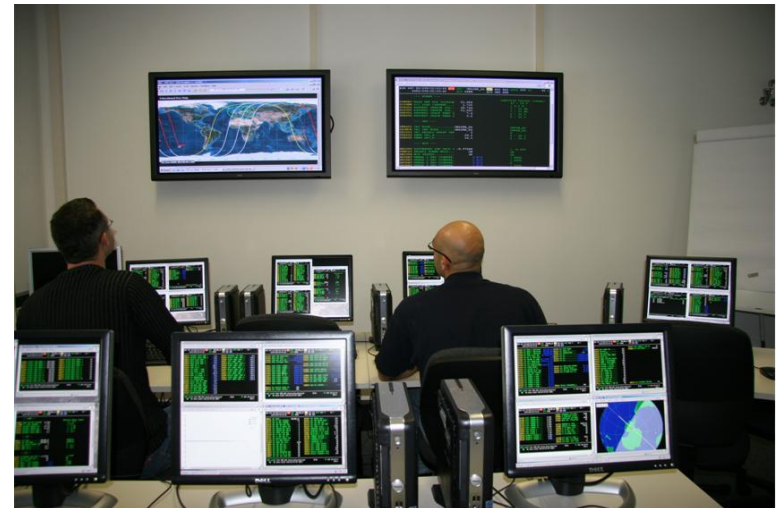

Satellite Mission Control Centre of TU Berlin

Elements of a Satellite Mission: Mission Operations and Data Processing, Archiving and Distribution

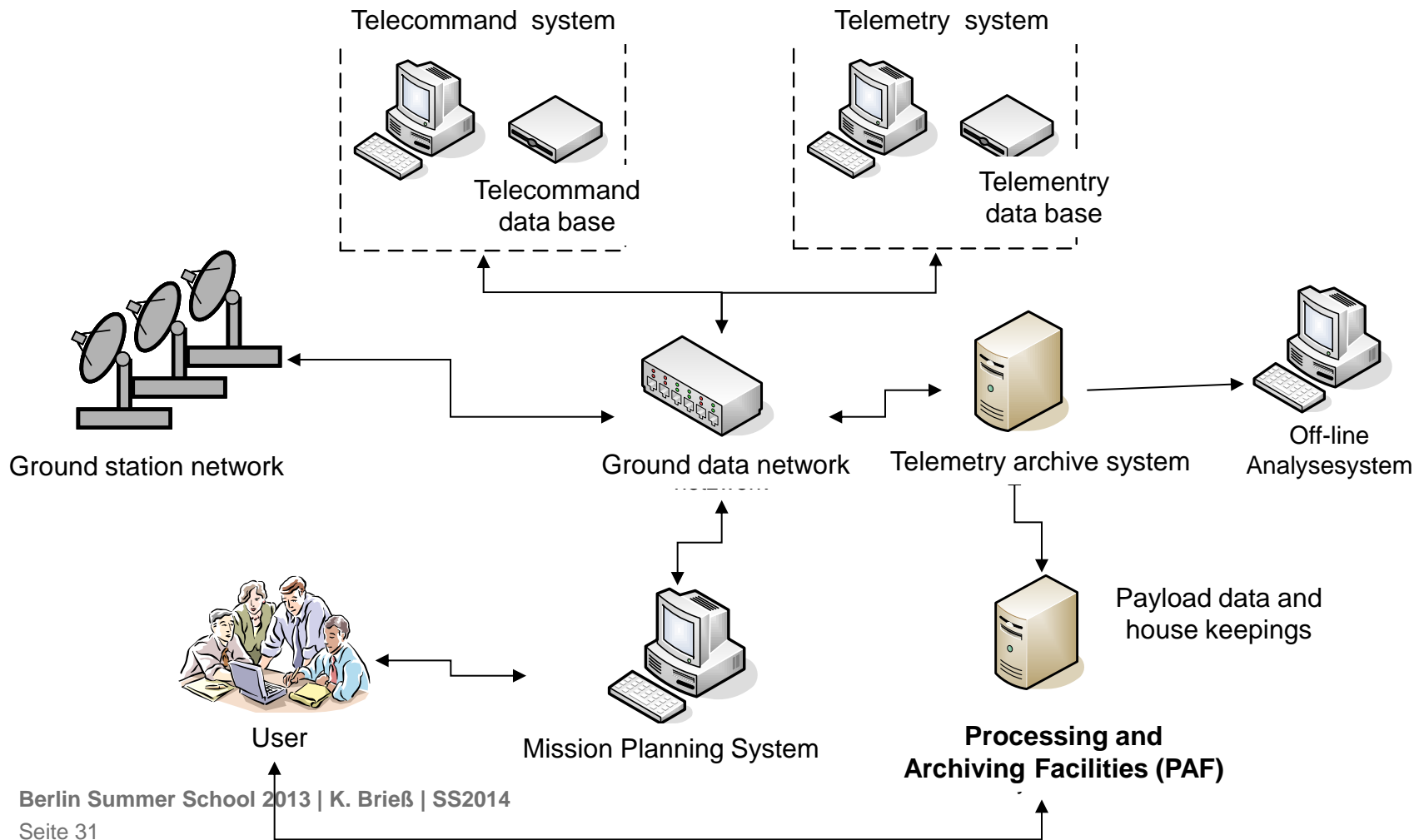

Elements of a Satellite Mission: the User

User of satellites can be divided into following categories:

- scientific user,
- private user (e.g. communication companies),
- operational user (e.g. weather services),
- non-private industrial user,
- official duties (government agencies, administrations),
- military user,
- non-governmental user,
- universities and educational institutions.

Users should be included in discussions from the beginning of the idea of a satellite mission.



“User” of satellites during an educational course in the mission control centre of TU Berlin

SEGMENTS OF A SATELLITE MISSION AND MISSION ARCHITECTURE

Segments of a Satellite Mission

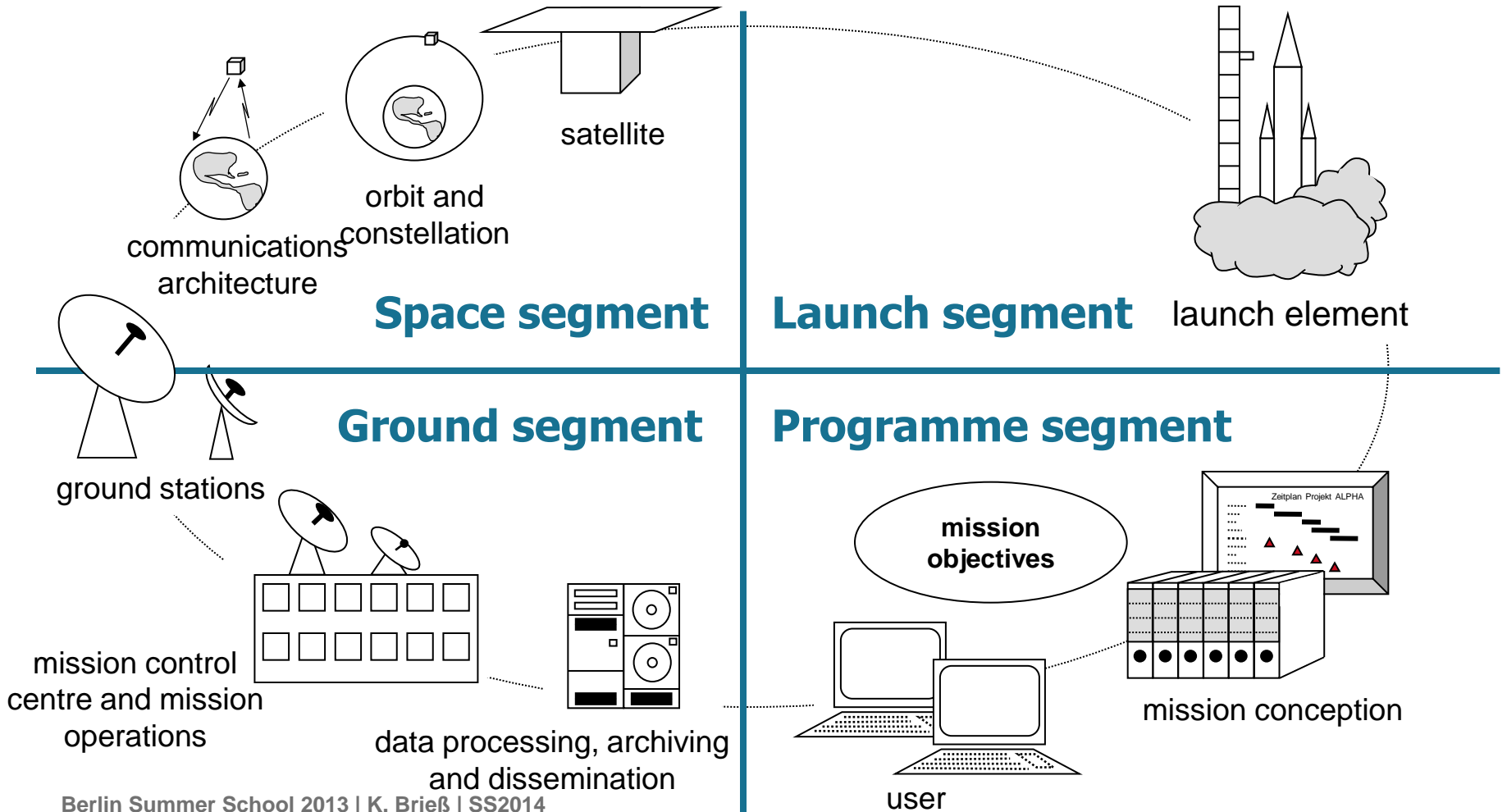

Example for an other Segmentation of a Satellite Mission

3 Segments of a Global Satellite Navigation System (GNSS):

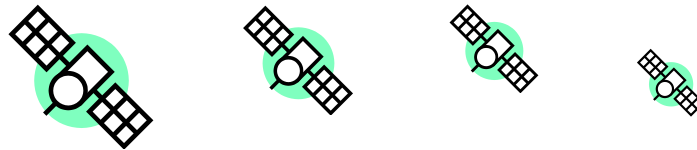

**Space
segment**

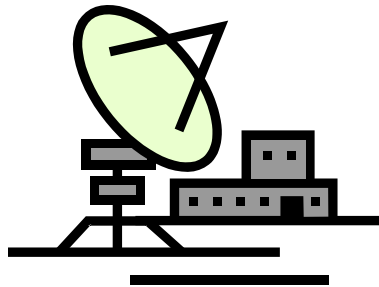

Control segment

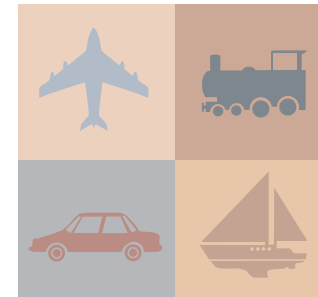

User segment

Mission Architecture

The arrangement of the mission elements and their interactions is characterised by the **architecture of the space mission**.

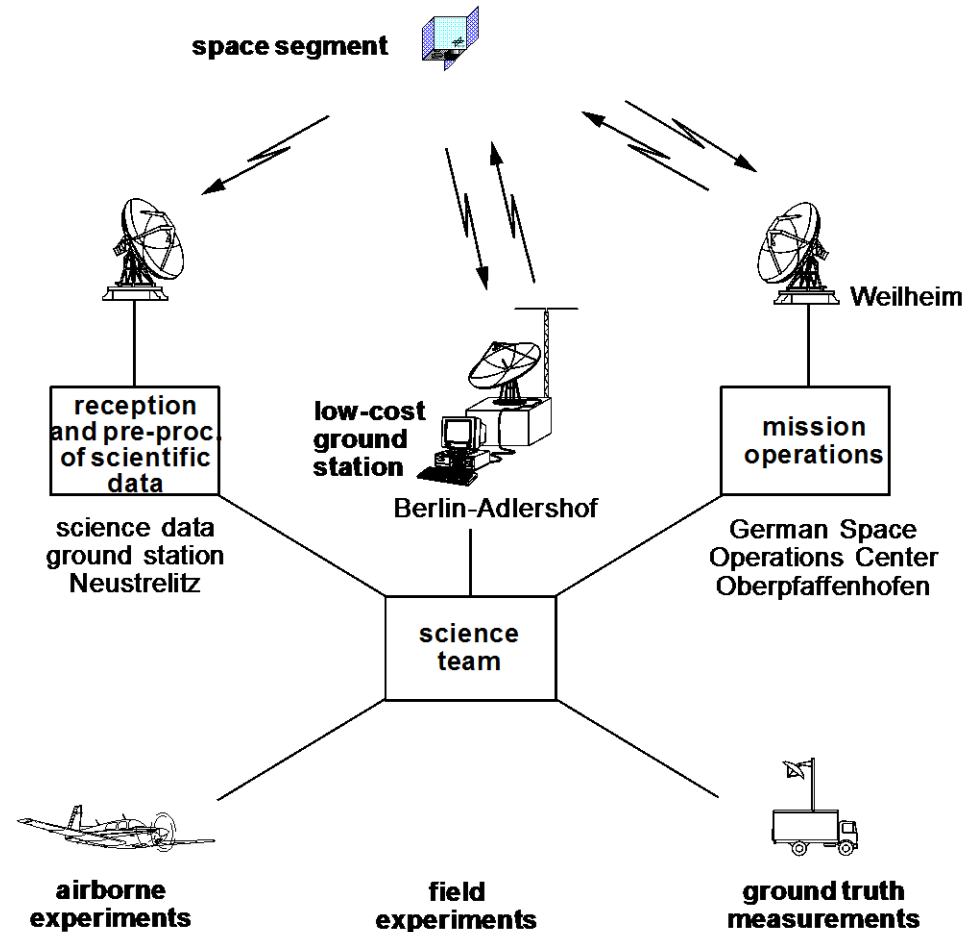

Mission architecture
of the BIRD mission
of DLR

EXAMPLE OF INNOVATIVE CUBESAT PAYLOADS

New Opportunities by CubeSats

- Inspection and repair of space infrastructure
- Dedicated environment and disaster monitoring missions
- Increase the time coverage or the area coverage of large single Earth remote sensing satellites by supplementation with nano or pico satellites in formation
- Environmental monitoring with high time coverage by satellite formations
- Low-cost missions in science niches
- In-orbit verification of new technologies
- Store and forward communication

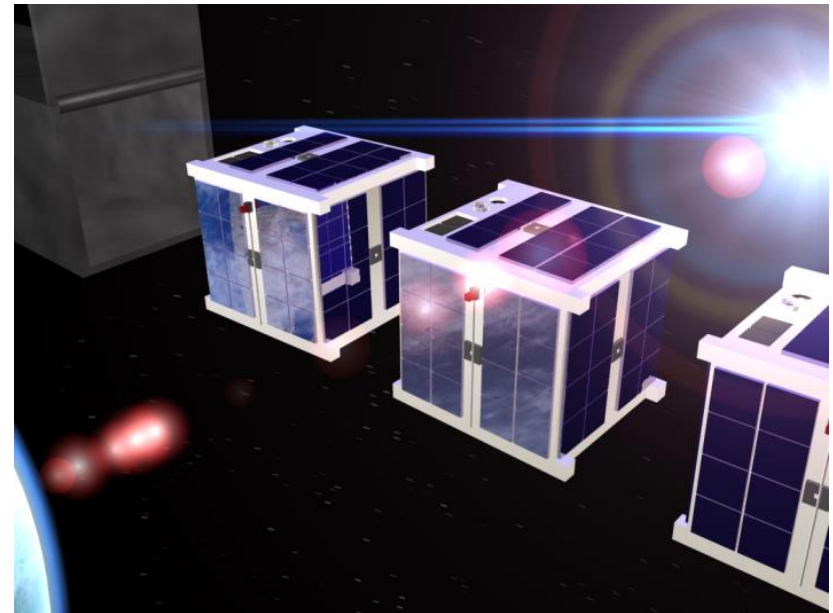

CubeSats during separation process

Prospective Payload for a Double CubeSat: UV-VIS-Mini-Hadamard-Spectrometer

Patent pending from Germany [Wut02]
Suitable and qualified for space applications

Main units:

Diode array spectrometer with
Detector line
Imaging grating
2-dim. Hadamard Mask as entrance aperture

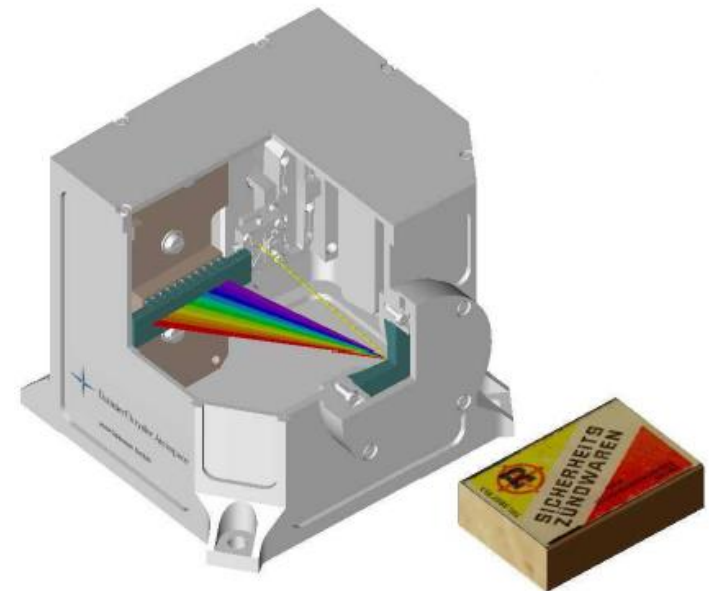

UV-VIS-Mini-Hadamard-Spectrometer

Principle:

The light goes through a programmable Si-micro slit array, is modulated in space and in n sum spectra divided the Signal Noise Ratio will be increased.

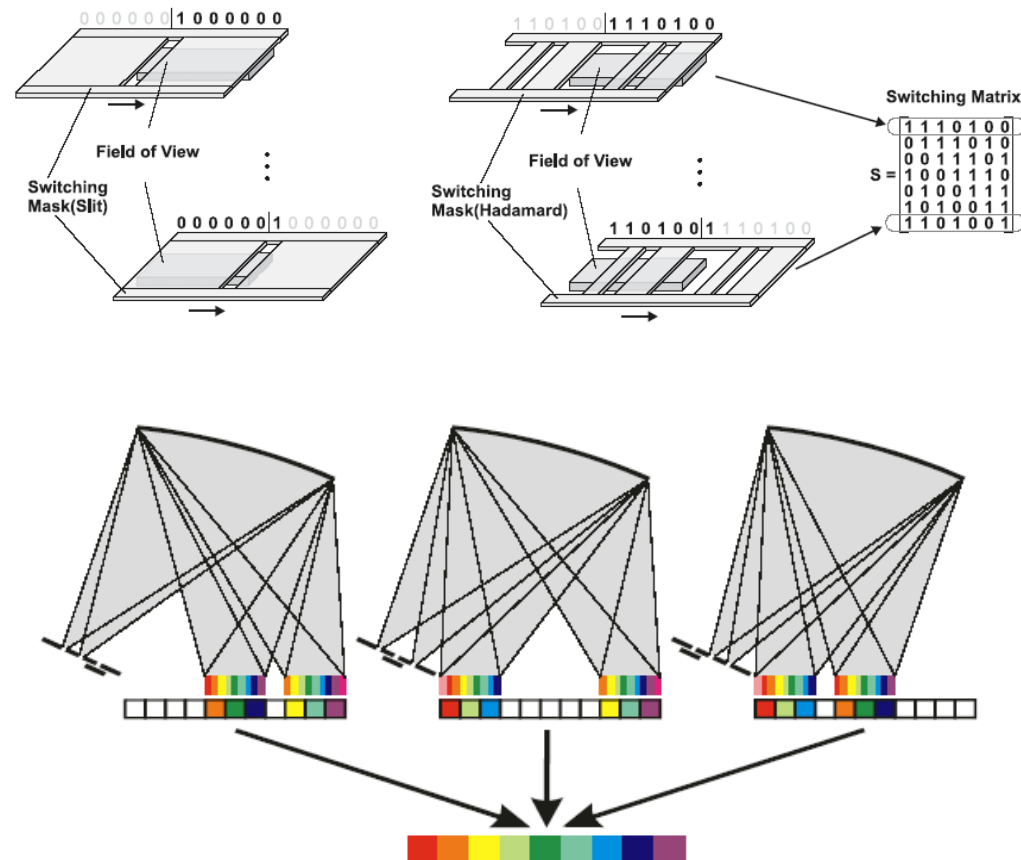

UV-VIS-Mini-Hadamard-Spectrometer

Functional principle

Measurement

$$\vec{m} = \overline{H} \cdot \vec{s} + \vec{n}$$

with

m – measurement values

H – Hadamard-Matrix

s – signal (original)

s_r – reconstructed signal

Reconstruction

$$\vec{s} = \overline{H}^{-1} \cdot \vec{m}$$

example:

$$\begin{pmatrix} m_1 \\ m_2 \\ m_3 \end{pmatrix} = \begin{pmatrix} 0 & 1 & 1 \\ 1 & 0 & 1 \\ 1 & 1 & 0 \end{pmatrix} \cdot \begin{pmatrix} s_1 \\ s_2 \\ s_3 \end{pmatrix} + \begin{pmatrix} n_1 \\ n_2 \\ n_3 \end{pmatrix}$$

$$\begin{pmatrix} s_{r1} \\ s_{r2} \\ s_{r3} \end{pmatrix} = \frac{1}{2} \begin{pmatrix} -1 & 1 & 1 \\ 1 & -1 & 1 \\ 1 & 1 & -1 \end{pmatrix} \cdot \begin{pmatrix} m_1 \\ m_2 \\ m_3 \end{pmatrix}$$

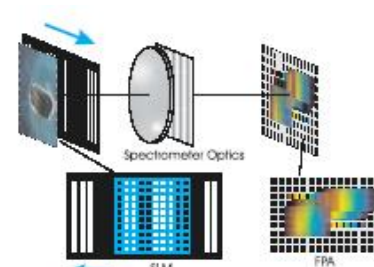
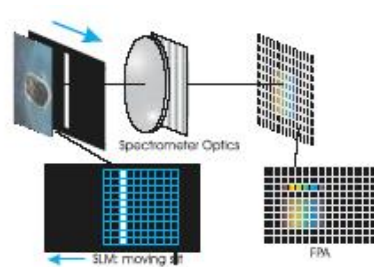

UV-VIS-Mini-Hadamard-Spectrometer

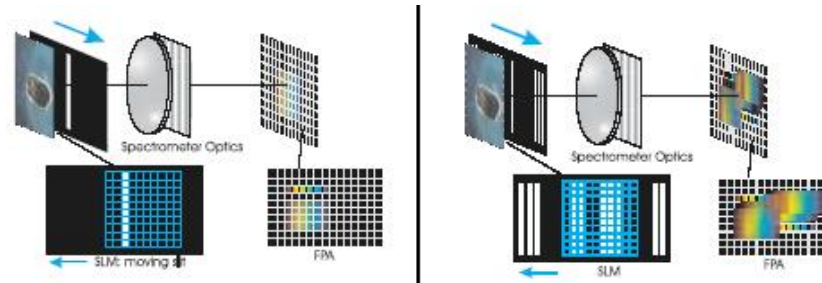

Radiometric performance in comparison between a classical micro-spectrometer and the Hadamard-Transform-Spectrometer by simulation [Wut02]

Literature

- Ber05 Berlin, Peter, Satellite Platform Design, Kiruna 2005
- Bro02 Brown, Charles D., Elements of Spacecraft Design, Reston, 2002
- Lar99 Larson, Wiley, Wertz, James, Space Mission Analysis and Design, Dordrecht, 1999
- Ley09 Ley, W., Wittmann, K., Hallmann, W., Handbook of Space Technology. John Wiley & Sons, 2009
- Wer80 Wertz, James, R., Spacecraft Attitude Determination and Control, Springer, 1980
- Wut02 A. Wuttig, R. Riesenber, Sensitive Hadamard Transform Imaging Spectrometer with a simple MEMS, Paper, Crete 2002.